

SUPPLY ARRANGEMENT FOR WORK SPACES

Category 3: Metal Filing & Storage Cabinets

NMSA # E60PQ-140003/043/PQ

Product Pricing Guide

Canada Ceiling Prices for NMSA

Effective January 18, 2016

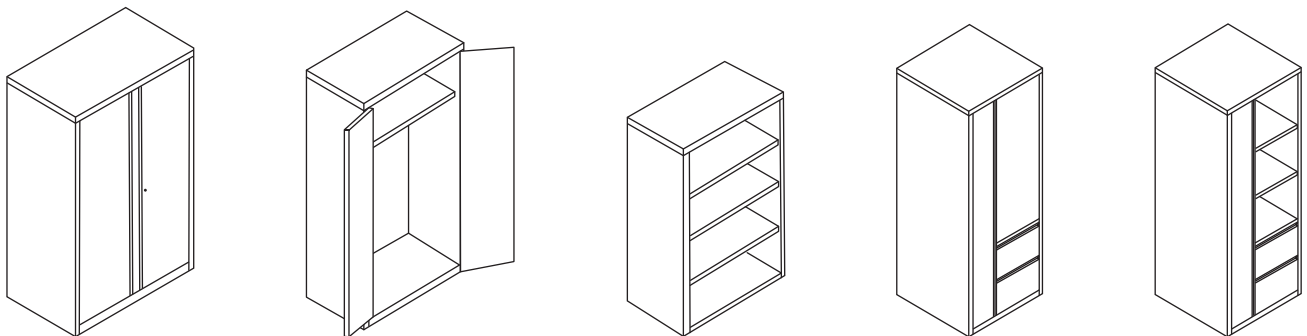
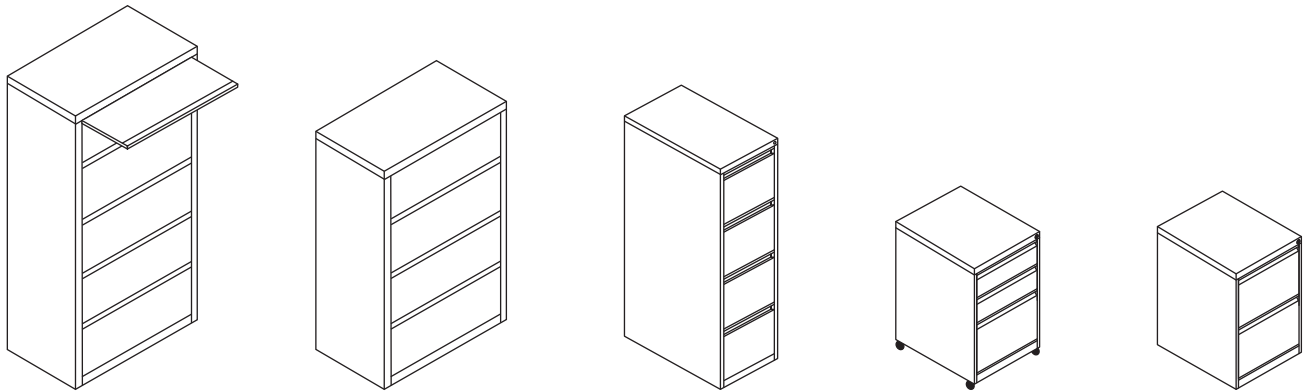

PERFIX INC.

450-435-0540
sales@perfix.ca
www.perfix.ca

SUPPLY ARRANGEMENT FOR WORKSPACES
NMSA # E60PQ-140003/043/PQ
Effective January 18, 2016

SERIES	PAGE
STORAGE CABINETS / WARDROBE CABINETS	3
OPEN WARDROBE CABINETS	4
OPEN BOOKCASES	5
LOCKING LATERAL FILING CABINETS	6
LOCKING VERTICAL FILING CABINETS.	7
PERSONAL STORAGE TOWERS	9
PEDESTALS (ON CASTERS).	10
PEDESTALS (ON GLIDES)	11

DELIVERIES

2 - 4 weeks.

COLOR FINISHES

12 standard colors, please refer to color chart.

TRANSPORTATION

Extra, F.O.B, our factory Boisbriand, Qc.
Please contact our Customer Service Department for Freight quote.

INSTALLATION

Extra, Please contact our Customer Service Department for Installation quote.

PRICING

Prices indicated are ceiling prices.



STORAGE CABINETS

HINGED DOORS

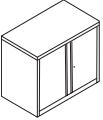
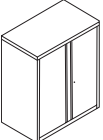
MODEL	DESCRIPTION	GOVERNMENT GoCUIC	WIDTH " (mm)	DEPTH " (mm)	HEIGHT " (mm)	PERFIX CODE	CEILING PRICE \$
	Two-door storage cabinet 1 shelf	SCSC2DSCxxx18362433	36 (914)	18 (457)	27 ⁷ / ₈ (708)	20-1-361824	421.00
		SCSC2DSCxxx20362433	36 (914)	20 (508)	27 ⁷ / ₈ (708)	20-1-362024	467.78
		SCSC2DSCxxx24362433	36 (914)	24 (610)	27 ⁷ / ₈ (708)	20-1-362424	561.33
		SCSC2DSCxxx18422433	42 (1067)	18 (457)	27 ⁷ / ₈ (708)	20-1-421824	448.34
		SCSC2DSCxxx20422433	42 (1067)	20 (508)	27 ⁷ / ₈ (708)	20-1-422024	498.15
		SCSC2DSCxxx24422433	42 (1067)	24 (610)	27 ⁷ / ₈ (708)	20-1-422424	597.78
	Two-door storage cabinet 2 shelves	SCSC2DSCxxx18363443	36 (914)	18 (457)	40 ¹ / ₁₆ (1018)	20-2-361836	497.54
		SCSC2DSCxxx20363443	36 (914)	20 (508)	40 ¹ / ₁₆ (1018)	20-2-362036	552.83
		SCSC2DSCxxx24363443	36 (914)	24 (610)	40 ¹ / ₁₆ (1018)	20-2-362436	663.39
		SCSC2DSCxxx18423443	42 (1067)	18 (457)	40 ¹ / ₁₆ (1018)	20-2-421836	524.88
		SCSC2DSCxxx20423443	42 (1067)	20 (508)	40 ¹ / ₁₆ (1018)	20-2-422036	583.20
		SCSC2DSCxxx24423443	42 (1067)	24 (610)	40 ¹ / ₁₆ (1018)	20-2-422436	699.84
	Two-door storage cabinet 3 shelves	SCSC2DSCxxx18364454	36 (914)	18 (457)	53 ³ / ₈ (1356)	20-3-361848	574.09
		SCSC2DSCxxx20364454	36 (914)	20 (508)	53 ³ / ₈ (1356)	20-3-362048	637.88
		SCSC2DSCxxx24364454	36 (914)	24 (610)	53 ³ / ₈ (1356)	20-3-362448	765.45
		SCSC2DSCxxx18424454	42 (1067)	18 (457)	53 ³ / ₈ (1356)	20-3-421848	612.36
		SCSC2DSCxxx20424454	42 (1067)	20 (508)	53 ³ / ₈ (1356)	20-3-422048	680.40
		SCSC2DSCxxx24424454	42 (1067)	24 (610)	53 ³ / ₈ (1356)	20-3-422448	813.48

WARDROBE CABINETS

HINGED DOORS

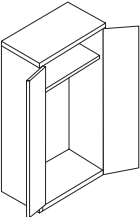
	Two-door wardrobe cabinet 1 shelf 1 coat rod	WARD2DSCxxx20364454	36 (914)	20 (508)	53 ³ / ₈ (1356)	20-W-809-362048	588.30
		WARD2DSCxxx24364454	36 (914)	24 (610)	53 ³ / ₈ (1356)	20-W-809-362448	705.96
		WARD2DSCxxx20424454	42 (1067)	20 (508)	53 ³ / ₈ (1356)	20-W-809-422048	628.76
		WARD2DSCxxx24424454	42 (1067)	24 (610)	53 ³ / ₈ (1356)	20-W-809-422448	754.45

OPEN WARDROBE CABINETS

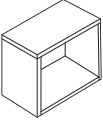
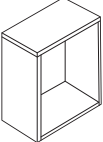
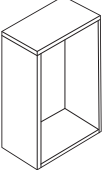
MODEL	DESCRIPTION	GOVERNMENT GoCUIC	WIDTH " (mm)	DEPTH " (mm)	HEIGHT " (mm)	PERFIX CODE	CEILING PRICE \$
	Open wardrobe cabinet 1 coat rod	WARDOPSCxxx18302433	30 (762)	18 (457)	27 ⁷ / ₈ (708)	20-809-301824	246.04
		WARDOPSCxxx18362433	36 (914)	18 (457)	27 ⁷ / ₈ (708)	20-809-361824	267.71
		WARDOPSCxxx18422433	42 (1067)	18 (457)	27 ⁷ / ₈ (708)	20-809-421824	306.18
		WARDOPSCxxx18482433	48 (1219)	18 (457)	27 ⁷ / ₈ (708)	20-809-481824	349.92
		WARDOPSCxxx20302433	30 (762)	20 (508)	27 ⁷ / ₈ (708)	20-809-302024	273.38
		WARDOPSCxxx20362433	36 (914)	20 (508)	27 ⁷ / ₈ (708)	20-809-362024	297.68
		WARDOPSCxxx20422433	42 (1067)	20 (508)	27 ⁷ / ₈ (708)	20-809-422024	340.20
		WARDOPSCxxx20482433	48 (1219)	20 (508)	27 ⁷ / ₈ (708)	20-809-482024	388.80
	Open wardrobe cabinet 1 coat rod	WARDOPSCxxx18303443	30 (762)	18 (457)	40 ¹ / ₁₆ (1018)	20-809-301836	306.16
		WARDOPSCxxx18363443	36 (914)	18 (457)	40 ¹ / ₁₆ (1018)	20-809-361836	333.50
		WARDOPSCxxx18423443	42 (1067)	18 (457)	40 ¹ / ₁₆ (1018)	20-809-421836	388.19
		WARDOPSCxxx18483443	48 (1219)	18 (457)	40 ¹ / ₁₆ (1018)	20-809-481836	490.98
		WARDOPSCxxx20303443	30 (762)	20 (508)	40 ¹ / ₁₆ (1018)	20-809-302036	340.20
		WARDOPSCxxx20363443	36 (914)	20 (508)	40 ¹ / ₁₆ (1018)	20-809-362036	370.58
		WARDOPSCxxx20423443	42 (1067)	20 (508)	40 ¹ / ₁₆ (1018)	20-809-422036	431.33
		WARDOPSCxxx20483443	48 (1219)	20 (508)	40 ¹ / ₁₆ (1018)	20-809-482036	545.54
	Open wardrobe cabinet 1 coat rod	WARDOPSCxxx18304454	30 (762)	18 (457)	53 ³ / ₈ (1356)	20-809-301848	382.73
		WARDOPSCxxx18364454	36 (914)	18 (457)	53 ³ / ₈ (1356)	20-809-361848	410.06
		WARDOPSCxxx18424454	42 (1067)	18 (457)	53 ³ / ₈ (1356)	20-809-421848	464.74
		WARDOPSCxxx18484454	48 (1219)	18 (457)	53 ³ / ₈ (1356)	20-809-481848	613.45
		WARDOPSCxxx20304454	30 (762)	20 (508)	53 ³ / ₈ (1356)	20-809-302048	425.25
		WARDOPSCxxx20364454	36 (914)	20 (508)	53 ³ / ₈ (1356)	20-809-362048	455.63
		WARDOPSCxxx20424454	42 (1067)	20 (508)	53 ³ / ₈ (1356)	20-809-422048	516.38
		WARDOPSCxxx20484454	48 (1219)	20 (508)	53 ³ / ₈ (1356)	20-809-482048	681.62

OPEN BOOKCASES

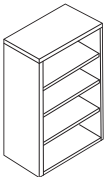
MODEL	DESCRIPTION	GOVERNMENT GoCUIC	WIDTH " (mm)	DEPTH " (mm)	HEIGHT " (mm)	PERFIX CODE	CEILING PRICE \$
	Open bookcase 1 shelf	SCSCOPSCxxx18302433	30 (762)	18 (457)	27 ⁷ / ₈ (708)	12-1-301824	246.04
		SCSCOPSCxxx18362433	36 (914)	18 (457)	27 ⁷ / ₈ (708)	12-1-361824	267.71
		SCSCOPSCxxx18422433	42 (1067)	18 (457)	27 ⁷ / ₈ (708)	12-1-421824	306.18
		SCSCOPSCxxx18482433	48 (1219)	18 (457)	27 ⁷ / ₈ (708)	12-1-481824	349.92
		SCSCOPSCxxx20302433	30 (762)	20 (508)	27 ⁷ / ₈ (708)	12-1-302024	273.38
		SCSCOPSCxxx20362433	36 (914)	20 (508)	27 ⁷ / ₈ (708)	12-1-362024	297.68
		SCSCOPSCxxx20422433	42 (1067)	20 (508)	27 ⁷ / ₈ (708)	12-1-422024	340.20
		SCSCOPSCxxx20482433	48 (1219)	20 (508)	27 ⁷ / ₈ (708)	12-1-482024	388.80
	Open bookcase 2 shelves	SCSCOPSCxxx18303443	30 (762)	18 (457)	40 ¹ / ₁₆ (1018)	12-2-301836	306.18
		SCSCOPSCxxx18363443	36 (914)	18 (457)	40 ¹ / ₁₆ (1018)	12-2-361836	333.52
		SCSCOPSCxxx18423443	42 (1067)	18 (457)	40 ¹ / ₁₆ (1018)	12-2-421836	388.19
		SCSCOPSCxxx18483443	48 (1219)	18 (457)	40 ¹ / ₁₆ (1018)	12-2-481836	490.98
		SCSCOPSCxxx20303443	30 (762)	20 (508)	40 ¹ / ₁₆ (1018)	12-2-302036	340.20
		SCSCOPSCxxx20363443	36 (914)	20 (508)	40 ¹ / ₁₆ (1018)	12-2-362036	370.58
		SCSCOPSCxxx20423443	42 (1067)	20 (508)	40 ¹ / ₁₆ (1018)	12-2-422036	431.33
		SCSCOPSCxxx20483443	48 (1219)	20 (508)	40 ¹ / ₁₆ (1018)	12-2-482036	545.54
	Open bookcase 3 shelves	SCSCOPSCxxx18304454	30 (762)	18 (457)	53 ³ / ₈ (1356)	12-3-301848	382.73
		SCSCOPSCxxx18364454	36 (914)	18 (457)	53 ³ / ₈ (1356)	12-3-361848	410.06
		SCSCOPSCxxx18424454	42 (1067)	18 (457)	53 ³ / ₈ (1356)	12-3-421848	464.74
		SCSCOPSCxxx18484454	48 (1219)	18 (457)	53 ³ / ₈ (1356)	12-3-481848	613.45
		SCSCOPSCxxx20304454	30 (762)	20 (508)	53 ³ / ₈ (1356)	12-3-302048	425.25
		SCSCOPSCxxx20364454	36 (914)	20 (508)	53 ³ / ₈ (1356)	12-3-362048	455.63
		SCSCOPSCxxx20424454	42 (1067)	20 (508)	53 ³ / ₈ (1356)	12-3-422048	516.38
		SCSCOPSCxxx20484454	48 (1219)	20 (508)	53 ³ / ₈ (1356)	12-3-482048	681.62

LOCKING LATERAL FILING CABINETS

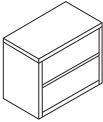
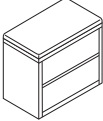
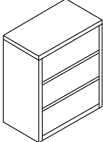
MODEL	DESCRIPTION	GOVERNMENT GoCUIC	WIDTH " (mm)	DEPTH " (mm)	HEIGHT " (mm)	PERFIX CODE	CEILING PRICE \$
	Lateral file Two (2) fixed front drawers	LLFC2Dxxxxx1830xxxx	30 (762)	18 (457)	27 ⁷ / ₈ (708)	2021-33-30	459.28
		LLFC2Dxxxxx2030xxxx	30 (762)	20 (508)	27 ⁷ / ₈ (708)	2021-600-302024	507.88
		LLFC2DFDxxx1836xxxx	36 (914)	18 (457)	27 ⁷ / ₈ (708)	2021-33-36	459.28
		LLFC2DFDxxx2036xxxx	36 (914)	20 (508)	27 ⁷ / ₈ (708)	2021-600-362024	507.88
		LLFC2DFDxxx1842xxxx	42 (1067)	18 (457)	27 ⁷ / ₈ (708)	2021-33-42	530.36
		LLFC2DFDxxx2042xxxx	42 (1067)	20 (508)	27 ⁷ / ₈ (708)	2021-600-422024	586.86
	Lateral file Two (2) fixed front drawers with cushion top	LLFC2DCTxxx1830xxxx	30 (762)	18 (457)	27 ⁷ / ₈ (708)	2021-609-301824	575.38
		LLFC2DCTxxx2030xxxx	30 (762)	20 (508)	27 ⁷ / ₈ (708)	2021-609-302024	623.98
		LLFC2DFCTxx1836xxxx	36 (914)	18 (457)	27 ⁷ / ₈ (708)	2021-609-361824	575.38
		LLFC2DFCTxxx2036xxxx	36 (914)	20 (508)	27 ⁷ / ₈ (708)	2021-609-362024	623.98
		LLFC2DFCTxxx1842xxxx	42 (1067)	18 (457)	27 ⁷ / ₈ (708)	2021-609-421824	665.36
		LLFC2DFCTxxx2042xxxx	42 (1067)	20 (508)	27 ⁷ / ₈ (708)	2021-609-422024	721.86
	Lateral file Three (3) fixed front drawers	LLFC3Dxxxxx1830xxxx	30 (762)	18 (457)	40 ¹ / ₁₆ (1018)	2031-333-30	595.97
		LLFC3Dxxxxx2030xxxx	30 (762)	20 (508)	40 ¹ / ₁₆ (1018)	2031-600-302036	658.55
		LLFC3DFDxxx1836xxxx	36 (914)	18 (457)	40 ¹ / ₁₆ (1018)	2031-333-36	597.97
		LLFC3DFDxxx2036xxxx	36 (914)	20 (508)	40 ¹ / ₁₆ (1018)	2031-600-362036	658.55
		LLFC3DFDxxx1842xxxx	42 (1067)	18 (457)	40 ¹ / ₁₆ (1018)	2031-333-42	761.82
		LLFC3DFDxxx2042xxxx	42 (1067)	20 (508)	40 ¹ / ₁₆ (1018)	2031-600-422036	842.82

LOCKING LATERAL FILING CABINETS

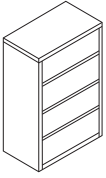
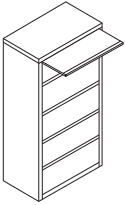
MODEL	DESCRIPTION	GOVERNMENT GoCUIC	WIDTH " (mm)	DEPTH " (mm)	HEIGHT " (mm)	PERFIX CODE	CEILING PRICE \$
	Lateral file Four (4) fixed front drawers	LLFC4Dxxxxx1830xxxx	30 (762)	18 (457)	53 ³ / ₈ (1356)	2041-3333-30	754.54
		LLFC4Dxxxxx2030xxxx	30 (762)	20 (508)	53 ³ / ₈ (1356)	2041-600-302048	833.51
		LLFC4DFDxxx1836xxxx	36 (914)	18 (457)	53 ³ / ₈ (1356)	2041-3333-36	754.54
		LLFC4DFDxxx2036xxxx	36 (914)	20 (508)	53 ³ / ₈ (1356)	2041-600-362048	833.51
		LLFC4DFDxxx1842xxxx	42 (1067)	18 (457)	53 ³ / ₈ (1356)	2041-3333-42	874.82
		LLFC4DFDxxx2042xxxx	42 (1067)	20 (508)	53 ³ / ₈ (1356)	2041-600-422048	967.16
	Lateral file Five (5) drawers First top drawer - receding front, other 4 drawers - fixed front	LLFC5DTRFFx1830xxxx	30 (762)	18 (457)	65 ¹ / ₂ (1664)	2051-13333-30	924.03
		LLFC5DTRFFx2030xxxx	30 (762)	20 (508)	65 ¹ / ₂ (1664)	2051-600-302060	924.03
		LLFC5DTRFFx1836xxxx	36 (914)	18 (457)	65 ¹ / ₂ (1664)	2051-13333-36	924.03
		LLFC5DTRFFx2036xxxx	36 (914)	20 (508)	65 ¹ / ₂ (1664)	2051-600-362060	1070.63
		LLFC5DTRFFx1842xxxx	42 (1067)	18 (457)	65 ¹ / ₂ (1664)	2051-13333-42	1093.53
		LLFC5DTRFFx2042xxxx	42 (1067)	20 (508)	65 ¹ / ₂ (1664)	2051-600-422060	1208.95

LOCKING VERTICAL FILING CABINETS

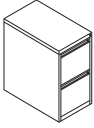
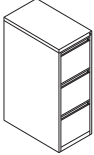
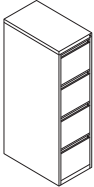
MODEL	DESCRIPTION	GOVERNMENT GoCUIC	WIDTH " (mm)	DEPTH " (mm)	HEIGHT " (mm)	PERFIX CODE	CEILING PRICE \$
	Vertical file Two (2) drawers	LVFC2Dxxxxx2818xxxx	18 (457)	28 (711)	27 ⁷ / ₈ (708)	99 VF 27-18	404.60
	Vertical file Three (3) drawers	LVFC3Dxxxxx2818xxxx	18 (457)	28 (711)	40 ¹ / ₁₆ (1018)	99 VF 40-18	568.62
	Vertical file Four (4) drawers	LVFC4Dxxxxx2818xxxx	18 (457)	28 (711)	53 ³ / ₈ (1356)	99 VF 53-18	601.43

PERSONAL STORAGE TOWERS

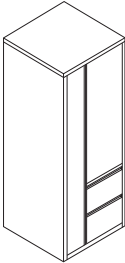
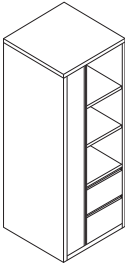

(R = wardrobe at right)

(L= wardrobe at left)

MODEL	DESCRIPTION	GOVERNMENT GoCUIC	WIDTH " (mm)	DEPTH " (mm)	HEIGHT " (mm)	PERFIX CODE	CEILING PRICE \$
	Wardrobe one side 2 file drawers at bottom and closed cupboard above, with lock	PSTxW2FCxxx2424Rxxx	24 (610)	24 (610)	53 ³ / ₈ (1356)	6R-02-242448	1011.49
		PSTxW2FCxxx2424Lxxx	24 (610)	24 (610)	53 ³ / ₈ (1356)	6L-02-242448	1011.49
		PSTxW2FCxxx2430Rxxx	30 (762)	24 (610)	53 ³ / ₈ (1356)	6R-02-302448	1230.19
		PSTxW2FCxxx2430Lxxx	30 (762)	24 (610)	53 ³ / ₈ (1356)	6L-02-302448	1230.19
		PSTxW2FCxxx2436Rxxx	36 (914)	24 (610)	53 ³ / ₈ (1356)	6R-02-362448	1503.56
		PSTxW2FCxxx2436Lxxx	36 (914)	24 (610)	53 ³ / ₈ (1356)	6L-02-362448	1503.56
		PSTxW2DLxxx2424Rxxx	24 (610)	24 (610)	66 (1676)	6R-02-242466	1259.71
		PSTxW2DLxxx2424Lxxx	24 (610)	24 (610)	66 (1676)	6L-02-242466	1259.71
		PSTxW2DLxxx2430Rxxx	30 (762)	24 (610)	66 (1676)	6R-02-302466	1532.00
		PSTxW2DLxxx2430Lxxx	30 (762)	24 (610)	66 (1676)	6L-02-302466	1532.00
		PSTxW2DLxxx2436Rxxx	36 (914)	24 (610)	66 (1676)	6R-02-362466	1872.07
		PSTxW2DLxxx2436Lxxx	36 (914)	24 (610)	66 (1676)	6L-02-362466	1872.07
	Wardrobe one side 2 file drawers at bottom and open cupboard above	PSTxW2FO54x2424Rxxx	24 (610)	24 (610)	53 ³ / ₈ (1356)	61R-02-242448	984.15
		PSTxW2FO54x2424Lxxx	24 (610)	24 (610)	53 ³ / ₈ (1356)	61L-02-242448	984.15
		PSTxW2FO54x2430Rxxx	30 (762)	24 (610)	53 ³ / ₈ (1356)	61R-02-302448	1225.81
		PSTxW2FO54x2430Lxxx	30 (762)	24 (610)	53 ³ / ₈ (1356)	61L-02-302448	1225.81
		PSTxW2FO54x2436Rxxx	36 (914)	24 (610)	53 ³ / ₈ (1356)	61R-02-362448	1467.48
		PSTxW2FO54x2436Lxxx	36 (914)	24 (610)	53 ³ / ₈ (1356)	61L-02-362448	1467.48
		PSTxW2FO66x2424Rxxx	24 (610)	24 (610)	66 (1676)	61R-02-242466	1255.81
		PSTxW2FO66x2424Lxxx	24 (610)	24 (610)	66 (1676)	61L-02-242466	1255.81
		PSTxW2FO66x2430Rxxx	30 (762)	24 (610)	66 (1676)	61R-02-302466	1526.53
		PSTxW2FO66x2430Lxxx	30 (762)	24 (610)	66 (1676)	61L-02-302466	1526.53
		PSTxW2FO66x2436Rxxx	36 (914)	24 (610)	66 (1676)	61R-02-362466	1827.24
		PSTxW2FO66x2436Lxxx	36 (914)	24 (610)	66 (1676)	61L-02-362466	1827.24

PEDESTALS

(ON CASTERS)

MODEL	DESCRIPTION	GOVERNMENT GoCUIC	WIDTH " (mm)	DEPTH " (mm)	HEIGHT " (mm)	PERFIX CODE	CEILING PRICE \$
	Mobile pedestal Box-Box-File Locking casters Depth 24" or 30" work surface	PEDSWS22xxxBBFxxxxxx	15 (381)	22 (559)	26 ⁷ / ₈ (683)	40-21-152223-27L	458.34
		PEDSMLC24xxxBBFxxxxxx	15 (381)	24 (610)	26 ⁷ / ₈ (683)	40-21-152423-27L	498.26
		PEDSWS28xxxBBFxxxxxx	15 (381)	28 (711)	26 ⁷ / ₈ (683)	40-21-152823-27L	507.55
		PEDSMLC30xxxBBFxxxxxx	15 (381)	30 (762)	26 ⁷ / ₈ (683)	40-21-153023-27L	542.54
	Mobile pedestal File-File Locking casters Depth 24" or 30" work surface	PEDSMCL22xxFFxxxxxx	15 (381)	22 (559)	26 ⁷ / ₈ (683)	40-02-152223-27L	463.81
		PEDSMLC24xxFFxxxxxx	15 (381)	24 (610)	26 ⁷ / ₈ (683)	40-02-152423-27L	503.72
		PEDSMCL28xxFFxxxxxx	15 (381)	28 (711)	26 ⁷ / ₈ (683)	40-02-152823-27L	513.02
		PEDSMLC30xxFFxxxxxx	15 (381)	30 (762)	26 ⁷ / ₈ (683)	40-02-153023-27L	548.01
	Mobile pedestal Box-File Cushion seat locking casters Depth 24" or 30" work surface	PEDSMCLC22xBFxxxxxx	15 (381)	22 (559)	21 ¹ / ₂ (546)	40-11-152221-L	473.73
		PEDSMCLC24xBFxxxxxx	15 (381)	24 (610)	21 ¹ / ₂ (546)	40-11-152421-L	507.63
		PEDSMCLC28xBFxxxxxx	15 (381)	28 (711)	21 ¹ / ₂ (546)	40-11-152821-L	588.38
		PEDSMCLC30xBFxxxxxx	15 (381)	30 (762)	21 ¹ / ₂ (546)	40-11-153021	622.28

PEDESTALS
(ON GLIDES)

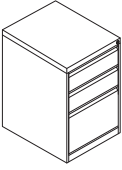
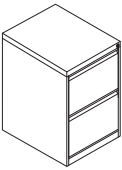
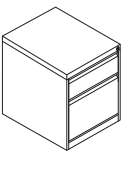
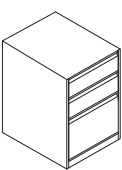
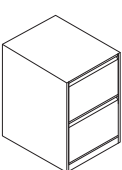
MODEL	DESCRIPTION	GOVERNMENT GoCUIC	WIDTH " (mm)	DEPTH " (mm)	HEIGHT " (mm)	PERFIX CODE	CEILING PRICE \$
	Freestanding pedestal Box-Box-File Depth 24" or 30" work surface	PEDSFSD22xxBBFxxxxx	15 (381)	22 (559)	26 ⁷ / ₈ (683)	41-21-152223-27	421.00
		PEDSFSD24xxBBFxxxxx	15 (381)	24 (610)	26 ⁷ / ₈ (683)	41-21-152423-27	458.18
		PEDSFSD28xxBBFxxxxx	15 (381)	28 (711)	26 ⁷ / ₈ (683)	41-21-152823-27	464.75
		PEDSFSD30xxBBFxxxxx	15 (381)	30 (762)	26 ⁷ / ₈ (683)	41-21-153023-27	497.55
	Freestanding pedestal File-File Depth 24" or 30" work surface	PEDSFSD22xxFFxxxxxx	15 (381)	22 (559)	26 ⁷ / ₈ (683)	41-02-152223-27	399.14
		PEDSFSD24xxFFxxxxxx	15 (381)	24 (610)	26 ⁷ / ₈ (683)	41-02-152423-27	434.13
		PEDSFSD28xxFFxxxxxx	15 (381)	28 (711)	26 ⁷ / ₈ (683)	41-02-152823-27	442.88
		PEDSFSD30xxFFxxxxxx	15 (381)	30 (762)	26 ⁷ / ₈ (683)	41-02-153023-27	473.49
	Freestanding pedestal Box-File Depth 24" or 30" work surface	PEDSFSD22xxBFxxxxxx	15 (381)	22 (559)	21 ¹ / ₂ (546)	41-11-152221-27	382.73
		PEDSFSD24xxBFxxxxxx	15 (381)	24 (610)	21 ¹ / ₂ (546)	41-11-152421	416.63
		PEDSFSD28xxBFxxxxxx	15 (381)	28 (711)	21 ¹ / ₂ (546)	41-11-152823-27	464.75
		PEDSFSD30xxBFxxxxxx	15 (381)	30 (762)	21 ¹ / ₂ (546)	41-11-153023-27	497.55
	Work surface supporting pedestal Box-Box-File Depth 24" or 30" work surface	PEDSWS22xxxBBFxxxxx	15 (381)	22 (559)	27 ⁷ / ₈ (699)	41-21-152224	421.00
		PEDSWS24xxxBBFxxxxx	15 (381)	24 (610)	27 ⁷ / ₈ (699)	41-21-152424	458.18
		PEDSWS28xxxBBFxxxxx	15 (381)	28 (711)	27 ⁷ / ₈ (699)	41-21-152824	464.75
		PEDSWS30xxxBBFxxxxx	15 (381)	30 (762)	27 ⁷ / ₈ (699)	41-21-153024	497.55
	Work surface supporting pedestal File-File Depth 24" or 30" work surface	PEDSWS22xxxFFxxxxx	15 (381)	22 (559)	27 ⁷ / ₈ (699)	41-02-152224	399.14
		PEDSWS24xxxFFxxxxx	15 (381)	24 (610)	27 ⁷ / ₈ (699)	41-02-152424	434.13
		PEDSWS28xxxFFxxxxx	15 (381)	28 (711)	27 ⁷ / ₈ (699)	41-02-152824	442.88
		PEDSWS30xxxFFxxxxx	15 (381)	30 (762)	27 ⁷ / ₈ (699)	41-02-153024	473.49

JANUARY 18, 2016



PERFIX INC.

HEAD OFFICE - SHOWROOM - PLANT :

645, Cure-Boivin blvd, Boisbriand, Qc, Canada J7G 2J2 • Tel.: 450-435-0540 • Email: sales@perfix.ca

www.perfix.ca